

C

C I N E M A

C I N E M A

SEATING COLLECTION

●●  FIGUERAS

**PLAY
IT AGAIN**

THE ART OF SEATING

Since 1929, designing, manufacturing and installing seats around the globe.

Over the years, Figueras has been a global reference in the design, manufacture and installation of fixed seating and the most innovative movable seating solutions.

With more than 10 million seats installed, we have proudly developed over 40,000 projects in more than 130 countries.

We are committed to provide optimum solutions for every project and to foster research and innovation in order to ensure the perfect response of our products. We use only first class materials that always undergo rigorous quality control in order to comply with specified country regulations, without ever forgetting our goal to achieve the best visual and technological performance.

Desde 1929, diseñando, fabricando e instalando butacas en todo el mundo.

A lo largo de los años, Figueras ha sido una referencia mundial en el diseño, fabricación e instalación de butacas fijas y de las más innovadoras soluciones de asientos móviles.

Con más de 10 millones de asientos instalados, estamos orgullosos de haber desarrollado más de 40.000 proyectos en más de 130 países.

Nos comprometemos a ofrecer soluciones óptimas para cada proyecto y a fomentar la investigación y la innovación para garantizar la perfecta respuesta de nuestros productos. Sólo utilizamos materiales de primera calidad que se someten siempre a un riguroso control de calidad para cumplir con las normativas específicas de cada país, sin olvidar nunca nuestro objetivo de conseguir las mejores prestaciones visuales y tecnológicas.



A family group of industrial companies which started its activity in 1987.

With an extensive international presence and a global business vision, Brand Corner has an international team of more than 1,500 professionals developing projects all over the world.

Brand Corner brings together more than 15 companies that operate in sectors as diverse as lighting, furniture, construction, small household appliances, security seals and systems, sanitary equipment oil and gas, plastic injection or cardboard and packaging.

Un grupo familiar de empresas industriales que inició su actividad en 1987.

Con una amplia presencia internacional y una visión empresarial global, Brand Corner cuenta con un equipo internacional de más de 1.500 profesionales que desarrollan proyectos en todo el mundo.

Brand Corner agrupa a más de 15 empresas que desarrollan su actividad en sectores tan diversos como iluminación, mobiliario, construcción, pequeño electrodoméstico, cierres de seguridad, material sanitario, gas y petróleo, inyección de plástico o cartón y embalajes.

GREEN ATTITUDE

At Figueras we are committed to be the best partner in the design and manufacture of high-end and movable seating solutions for public spaces and we trust to do it in a way to minimize, mitigate, and neutralize the environmental and social impact from our activity, based on the principles of the circular economy.

We believe in eco-design and we are constantly striving to innovate and find new and smarter ways to design and manufacture our products with the least impact on our planet, without affecting the quality of the final product.

We are therefore determined in our compliance with ISO 14001, a global, officially-recognized, voluntary standard that certifies Figueras' outstanding environmental performance. Figueras is also certified in the management standard UNE-EN ISO 14006, an environmental certification that applies to the design process of its products. By obtaining this certification, Figueras proves that it takes into consideration environmental aspects such as the sustainable origin of the materials used in the manufacture, the use of environmentally friendly processes, the non-use of toxic materials and a product design considering all their life cycle, including product recycling and maintenance service.

En Figueras estamos comprometidos en ser el mejor socio en el diseño y fabricación de soluciones de asientos móviles y butacas de alta gama para espacios públicos. Además, confiamos en hacerlo de forma que se minimice, mitigue y neutralice el impacto ambiental y social de nuestra actividad, basándonos en los principios de la economía circular.

En Figueras apostamos por el ecodiseño y nos esforzamos constantemente en innovar y encontrar nuevas y más inteligentes formas de diseñar y fabricar nuestros productos con el menor impacto en nuestro planeta, sin que ello afecte a la calidad del producto final.

En este sentido, estamos comprometidos con el cumplimiento de la norma ISO 14001, una norma voluntaria mundial reconocida oficialmente que certifica el excelente comportamiento medioambiental de Figueras. Por otro lado, Figueras está certificada también en la norma de gestión UNE-EN ISO 14006, una certificación medioambiental que se aplica al proceso de diseño de sus productos. Con la obtención de esta certificación, Figueras demuestra que tiene en cuenta aspectos medioambientales como el origen sostenible de los materiales utilizados en la fabricación, el uso de procesos respetuosos con el medio ambiente, la no utilización de materiales tóxicos y un diseño de producto que considera todo su ciclo de vida, incluyendo el reciclaje del producto y el servicio de mantenimiento.



SERVICES

Take your cinema experience beyond comfortable seating with exceptional service and support.

At Figueras we understand the importance of providing the best service to your cinema.

We offer a comprehensive range of services to ensure that your seating project is a success.

Our process includes:

PROJECT STUDY

Our team meets with you to determine the needs of the project, reviewing existing drawings with your staff members, architects, engineers and contractors.

SEATING SOLUTIONS ASSESSMENT

We review the types of seating options available based on your specific needs, guiding you through the range of possibilities we can offer your project.

SIGHT LINES AND ACOUSTIC REQUIREMENTS

Our team assesses site lines to determine the optimal style of seating, the best options regarding seat width and recommended back height, as well as sound absorption requirements.

FINISHINGS AND ACCESSORIES SELECTION

According to the client's needs, we work to determine the built-in functional features, the right type of fabric, and finishing materials based on the level of use and cleaning requirements.

LAYOUT

Our designers and engineers determine the optimal number of seats and the best seating configuration to achieve maximum space optimization and functionality based on the overall requirement and local regulations.

PROJECT PLANNING

Our team plans every detail of the project, from manufacturing to delivery and installation of the seating solution, to ensure a seamless process.

Lleve su experiencia en el cine más allá de la comodidad de las butacas, con un servicio y una asistencia excepcionales.

En Figueras entendemos la importancia de proporcionar el mejor servicio a su cine.

Ofrecemos una amplia gama de servicios para garantizar que su proyecto de butacas sea un éxito.

Nuestro procedimiento incluye:

ESTUDIO DEL PROYECTO

Nuestro equipo se reúne con usted para determinar las necesidades del proyecto y se revisan los planos existentes con los miembros de su personal, arquitectos, ingenieros y contratistas.

EVALUACIÓN DE SOLUCIONES DE BUTACAS

Revisamos los tipos de butacas disponibles en función de sus necesidades específicas y le guiamos a través de las distintas posibilidades que podemos ofrecer al proyecto.

LÍNEAS DE VISIÓN Y REQUISITOS ACÚSTICOS

Nuestro equipo evalúa las líneas de ubicación para determinar el estilo óptimo de las butacas, las mejores opciones recomendadas en cuanto a la anchura y la altura del respaldo de estas, así como los requisitos de absorción acústica.

SELECCIÓN DE ACABADOS Y ACCESORIOS

Según las necesidades del cliente, trabajamos para determinar las características funcionales incorporadas, el tipo de tejido adecuado y los materiales de acabado en función del nivel de uso y los requisitos de limpieza.

DISEÑO

Nuestros diseñadores e ingenieros determinan el número óptimo de butacas y la mejor configuración de las mismas para lograr la máxima optimización del espacio y funcionalidad en función de los requisitos generales y la normativa local.

PLANIFICACIÓN DEL PROYECTO

Nuestro equipo planifica cada detalle del proyecto, desde la fabricación hasta la entrega e instalación de las butacas, para garantizar un procedimiento perfecto.

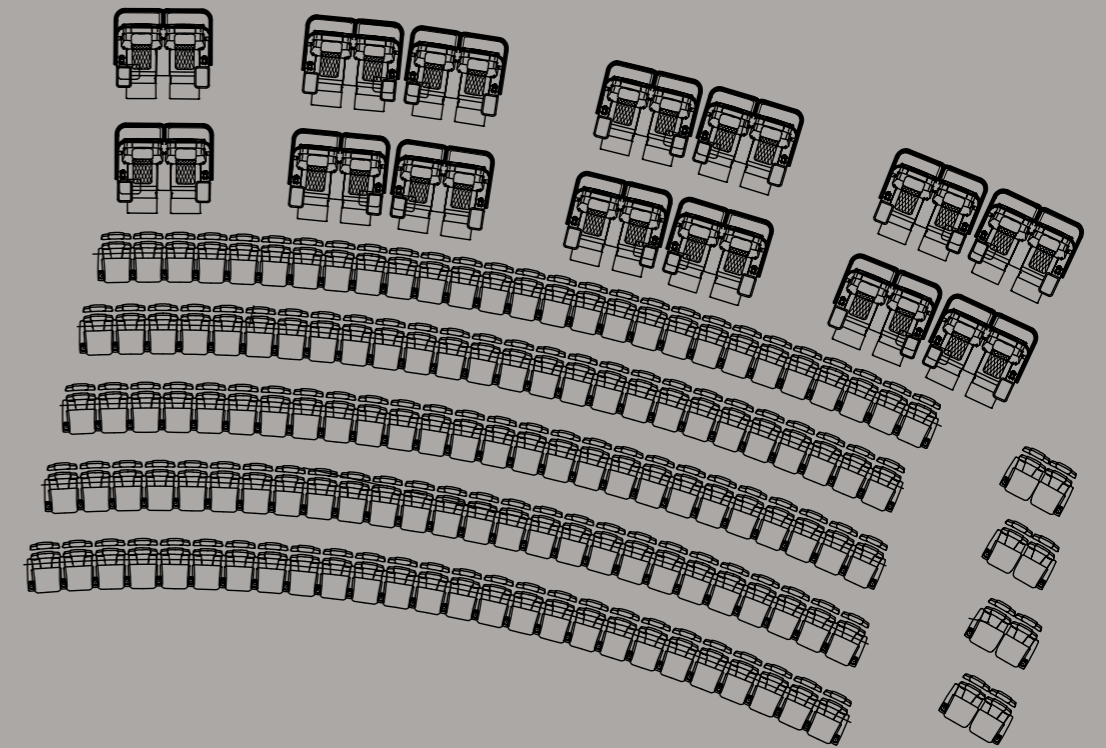

QUALITY CONTROL & WARRANTIES

Our seating products undergo rigorous quality control processes at every stage of the project to ensure the highest quality. We are ISO 9001, 14001, and 14006 certified, providing cinema owners and facilities managers with peace of mind.

DELIVERY AND INSTALLATION

With over 90 years of industry experience and a proven track record for exporting and installing seating in over 130 countries around the world, we guarantee prompt delivery and hassle-free installation.

LIFECYCLE AND MAINTENANCE SERVICES

We provide product warranties that meet or exceed industry standards and offer ongoing advice and support throughout the warranty period. Our experienced team ensures that cinema seating is maintained to the highest standards, ensuring customer comfort and safety for years to come.

SPARE PARTS AND REFURBISHING

We offer access to spare parts and refurbishing services to ensure that cinema seating is kept functioning properly. We can help identify and source spare parts or refurbish and reupholster existing seating to extend its lifespan, providing cinema owners and facilities managers with a reliable solution.

CONTROL DE CALIDAD Y GARANTÍAS

Nuestras butacas se someten a rigurosos procesos de control en cada fase del proyecto para garantizar la máxima calidad. Contamos con las certificaciones ISO 9001, 14001 y 14006, lo que proporciona tranquilidad a los propietarios y gestores de salas de cine.

ENTREGA E INSTALACIÓN

Con más de 90 años de experiencia en el sector y un historial probado de exportación e instalación de butacas en más de 130 países de todo el mundo, garantizamos una entrega rápida y una instalación sin complicaciones.

SERVICIOS DE CICLO DE VIDA Y MANTENIMIENTO

Proporcionamos garantías del producto que cumplen o superan las normas del sector y ofrecemos asesoramiento y asistencia continuos durante todo el periodo de garantía. Nuestro experimentado equipo garantiza el mantenimiento de las butacas de cine de acuerdo con las normas más exigentes, asegurando la comodidad y seguridad de los clientes durante años.

PIEZAS DE REPUESTO Y REACONDICIONAMIENTO

Ofrecemos acceso a piezas de repuesto y servicios de reacondicionamiento para garantizar que las butacas sigan funcionando correctamente a lo largo de los años. Podemos ayudar a identificar y conseguir piezas de repuesto o renovar y tapizar de nuevo las butacas existentes para prolongar su vida útil, proporcionando a los propietarios y gestores de salas de cine una solución fiable.



C

CINEMA

SEATING COLLECTION

The movie theatre experience is unique, for that reason we put our best efforts in designing and manufacturing state-of-the-art cinema seats that will make this experience unforgettable.

With more than 90 years in the cinema seats industry, our seats have been installed in the best Movie Theatres over the world. We are experts in designing the most comfortable and stylish seats with a special focus in durability and functionality.

We aim to design seats that will enhance the audience with the cinema experience by offering them all kind of cinema seating features that real cinema-goers will surely appreciate. Our seats can be completely tailored to suit your requirements and exquisitely fit in your venue.

La experiencia en el cine es única, por eso nos esforzamos en diseñar y fabricar asientos de cine de última generación que harán que esta experiencia sea inolvidable.

Con más de 90 años en la industria de las butacas para cine, nuestros asientos han sido instalados en las mejores salas de cine del mundo. Somos expertos en el diseño de las butacas más cómodas y elegantes con un claro enfoque en la durabilidad y la funcionalidad.

Nuestro propósito es diseñar asientos que mejoren la experiencia del público en el cine, ofreciéndoles unas butacas con todo tipo de características y comodidades que los verdaderos amantes del séptimo arte sabrán apreciar.



C I N E M A

SEATING COLLECTION

HOLLYWOOD

HOLLYWOOD

5400

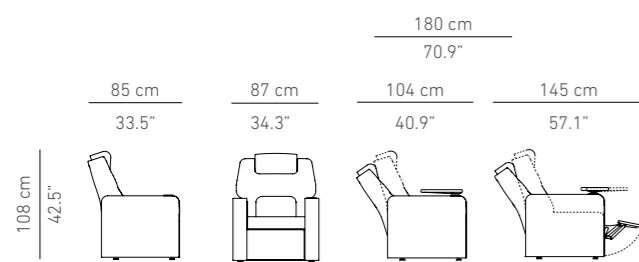

HOLLYWOOD

5400



Cinema City (Jerusalem, Israel)



Grand Cinemas - Obhur Mall (Jeddah, KSA)



Falcon Club Cinema (Minsk, Belarus)



Kinopark 9 - Saryarqa (Astana, Kazakhstan)



ACCESSORIES AND FINISHES_ACCESORIOS Y ACABADOS



Reclining backrest, footrest and headrest.
Respaldo, reposapiés y reposacabezas reclinables.



Touchpad.
Panel táctil.



Cleaning System.
Sistema de limpieza.



Lamp with two integrated USB ports.
Lámpara con dos puertos USB integrados.

TABLES_MESAS



Large table_Mesa grande.
15.94"x10.63" 405x270mm.



Double hinge.
Bisagra doble.

HOLLYWOOD

Twin

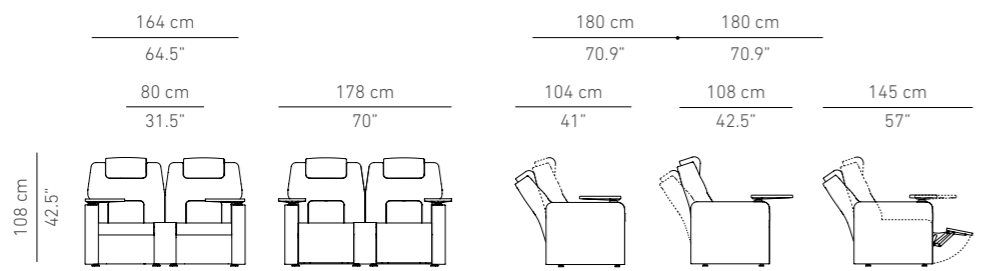

HOLLYWOOD

TWIN



Cinepolis - Pacific Palisades (Los Angeles, CA, USA)



Muvi - Mall of Arabia (Jeddah, KSA)



Cinepolis - Pacific Palisades (Los Angeles, CA, USA)



Vox Cinemas Kingdom Centre (Riyadh, Saudi Arabia)



Reel Cinemas - The Dubai Mall (Dubai, UAE)

ACCESSORIES AND FINISHES_ACCESORIOS Y ACABADOS



Row numbering.
Numeración de fila.



Integrated cupholder + drawer.
Portavasos integrado + cajón.

TABLES_MESAS



Large table_Mesa grande.
15.94"x10.63" 405x270mm.

PRIVACY MODULE_MÓDULO DE PRIVACIDAD



C I N E M A

SEATING COLLECTION

RIVA

●●● FIGUERAS

RIVA

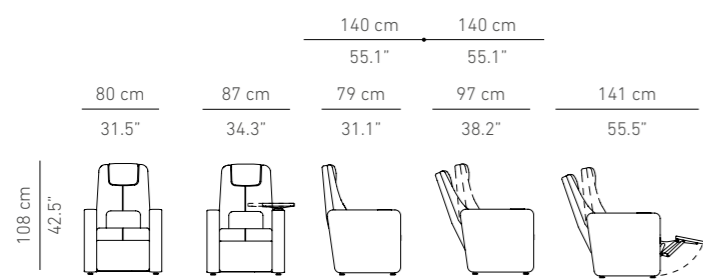

RIVA

ACCESSORIES AND FINISHES_ACCESORIOS Y ACABADOS



Integrated cupholder with seat numbering.
Posavasos integrado con numeración de butaca.



Touchpad.
Panel táctil.



ACCESSORIES AND FINISHES_ACCESORIOS Y ACABADOS



Lamp with two integrated USB ports.
Lámpara con dos puertos USB integrados.



Upholstered backshell.
Carcasa tapizada.

TABLES_MESAS



Customizable headrest.
Reposacabezas customizable.



Medium table. 13,4 x 7,9".
Mesa mediana. 340 X 200 mm.

RIVA

Twin

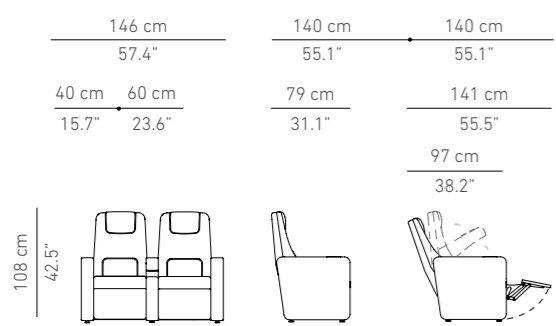

RIVA
TWIN



CineWil (Wil, Switzerland) ©David Halter



Kinopark 6 (Astana, Kazakhstan)



MBO The Starling (Kuala Lumpur, Malaysia)



Shaw Theaters - Balestier Mall (Singapore)



ACCESSORIES AND FINISHES_ACCESORIOS Y ACABADOS



Wireless charger.
Cargador inalámbrico.



Cupholder.
Portavasos.

PRIVACY MODULE_MÓDULO DE PRIVACIDAD



C I N E M A

SEATING COLLECTION

SMART

SMART

13010, 13011, 13012

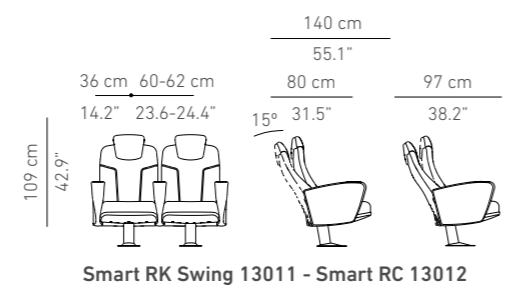
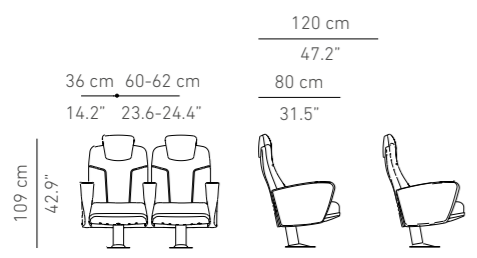
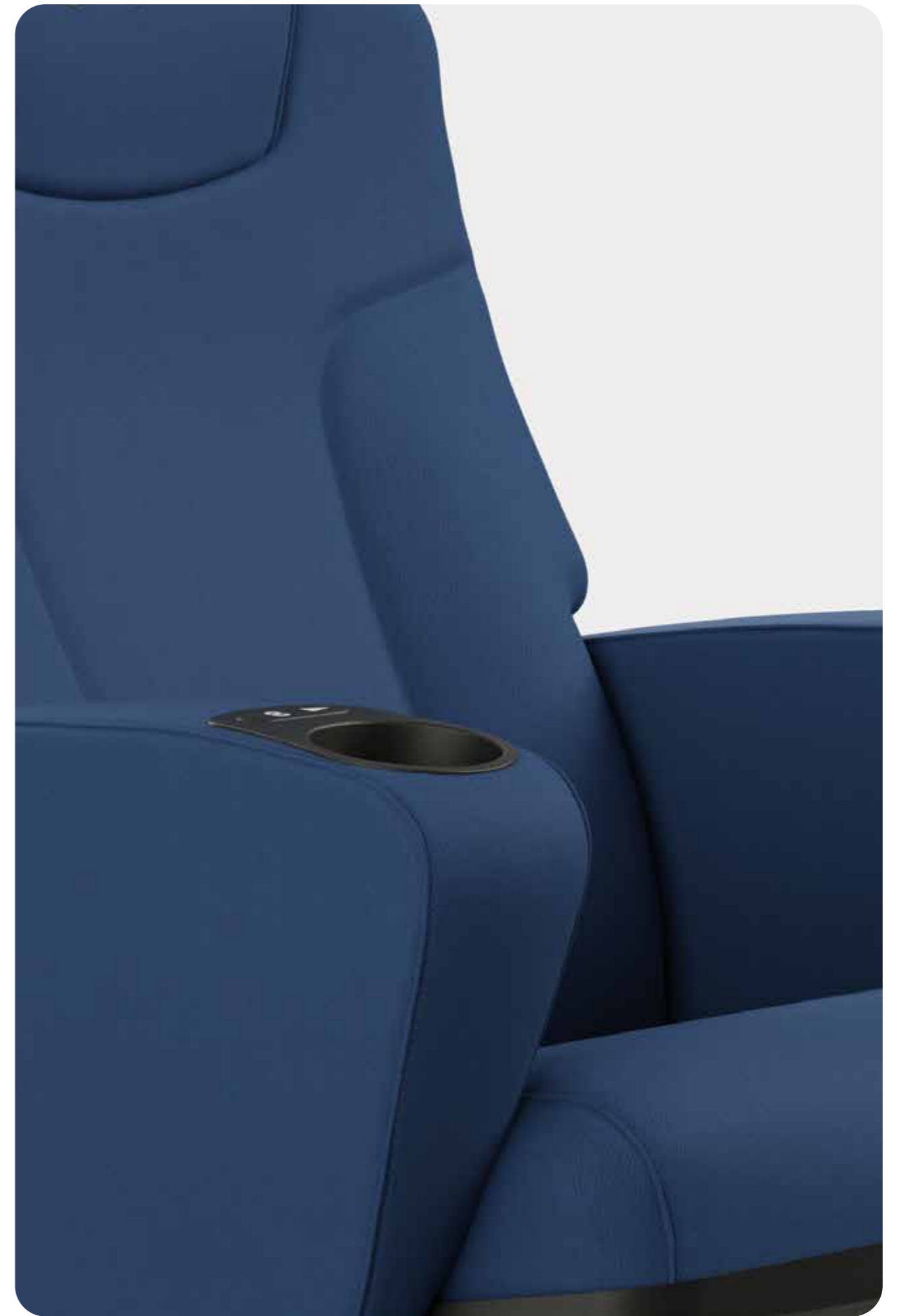

SMART

13010, 13011, 13012



Grand Cinemas Obhur Mall (Jeddah, KSA)



Muvi - Mall of Arabia (Jeddah, KSA)



Sony Pictures HQ (Singapore)



Grand Cinemas Obhur Mall (Jeddah, KSA)



Chaplin Cinemas (Astana, Kazakhstan)



Smart 13010 fix



Smart 13011 RK & Smart 13012 RC



Plastic injection shell
Carcasa de inyección de plástico

ACCESSORIES AND FINISHES_ACCESORIOS Y ACABADOS



Row numbering.
Numeración de fila.



Smart 13012 RC
Seat recliner button_Botón reclinador.



Cupholder.
Portavasos.



Customisable headrest: embroidery, colour, fabric.
Reposacabezas personalizable: bordado, color, tapicería.

TABLES_MESAS



ST Smart Table_ST Mesa Smart.
13"x5.9" 330x150mm.

SMART

13030

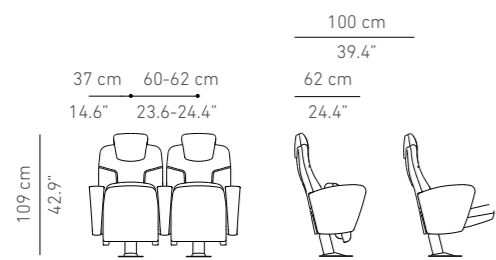
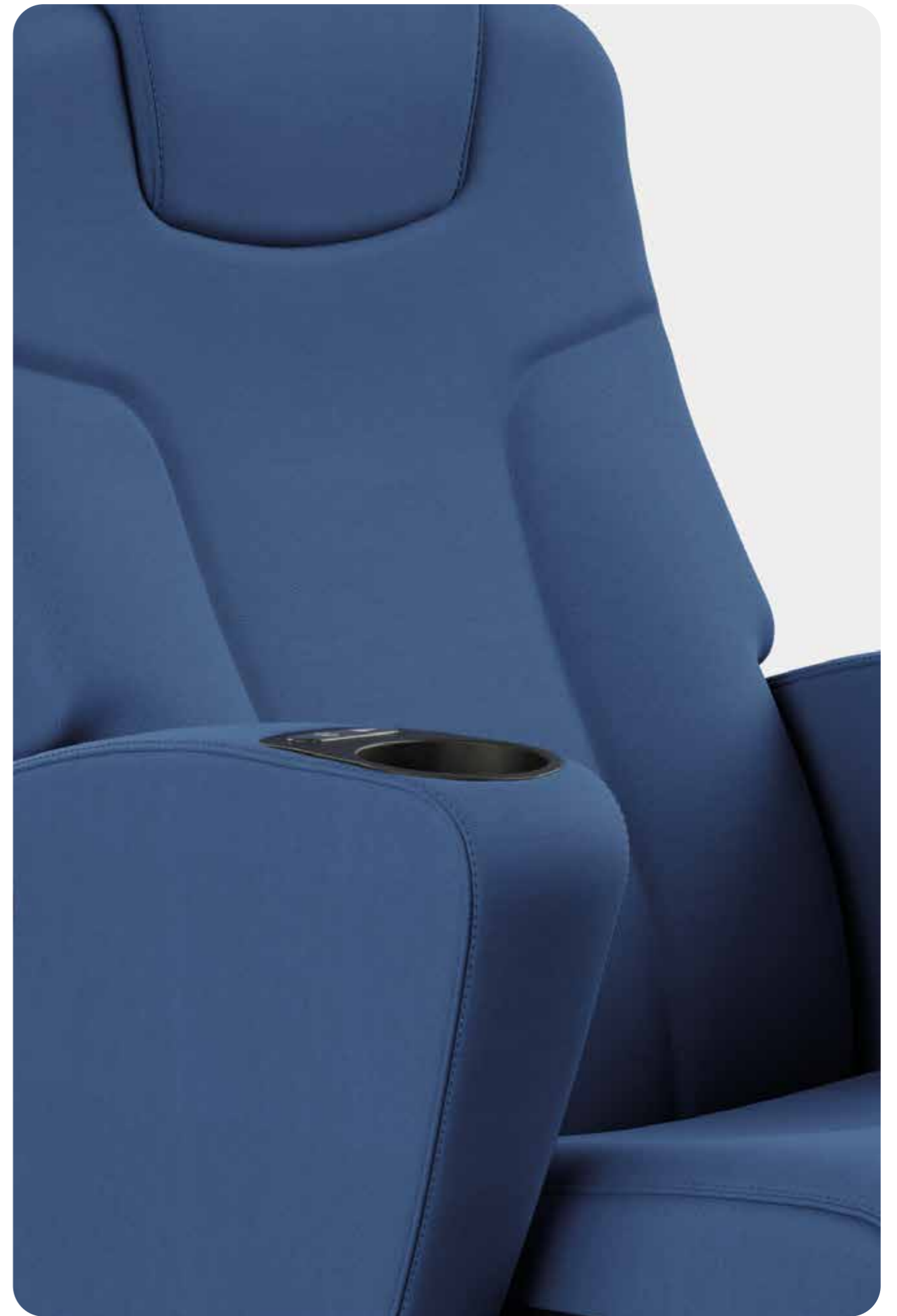

SMART

13030



Cinerama (Seattle, WA, USA)



Cinerama (Seattle, WA, USA)



ACCESSORIES AND FINISHES_ACCESORIOS Y ACABADOS



Upholstered seat shell.
Cubeta tapizada.



Cupholder.
Portavasos.



Seat without headrest.
Butaca sin reposacabezas.



Headrest integrated to the backrest.
Reposacabezas integrado en el respaldo.



C I N E M A

SEATING COLLECTION

MEGA

●●● FIGUERAS

MEGA

9112

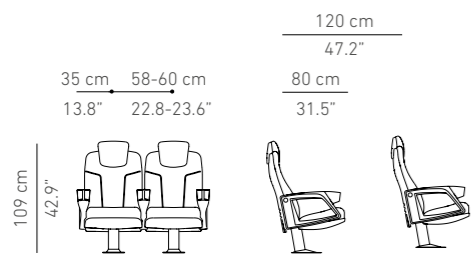

MEGA

9113

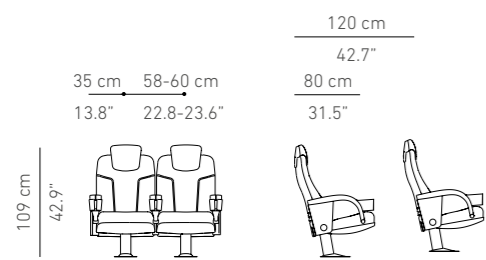
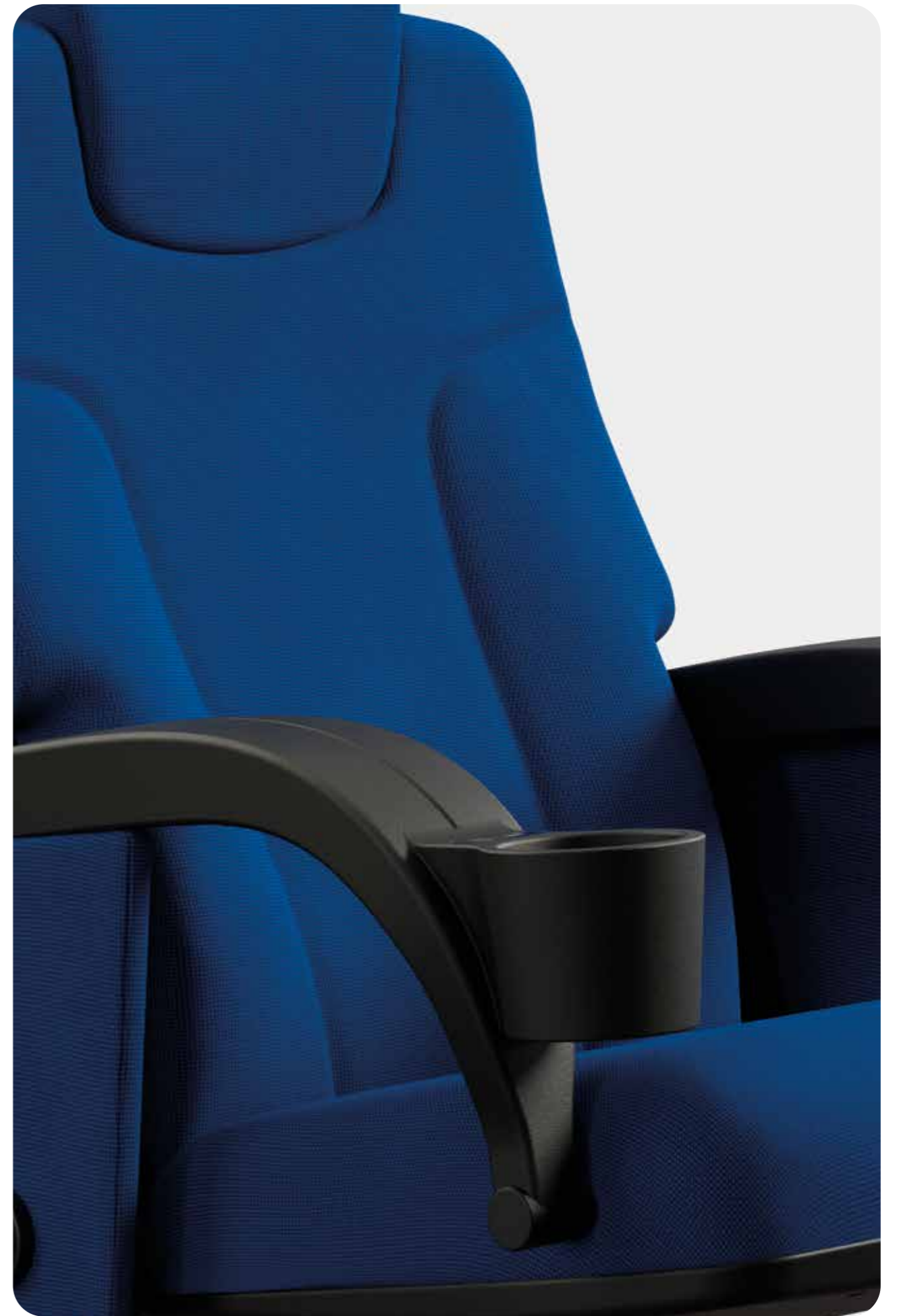

MEGA

9114

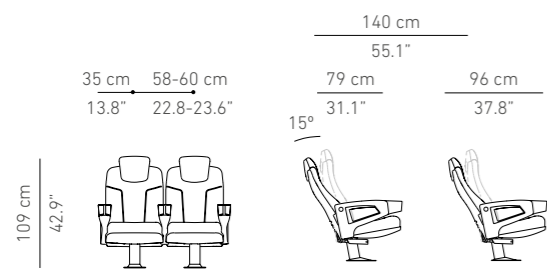
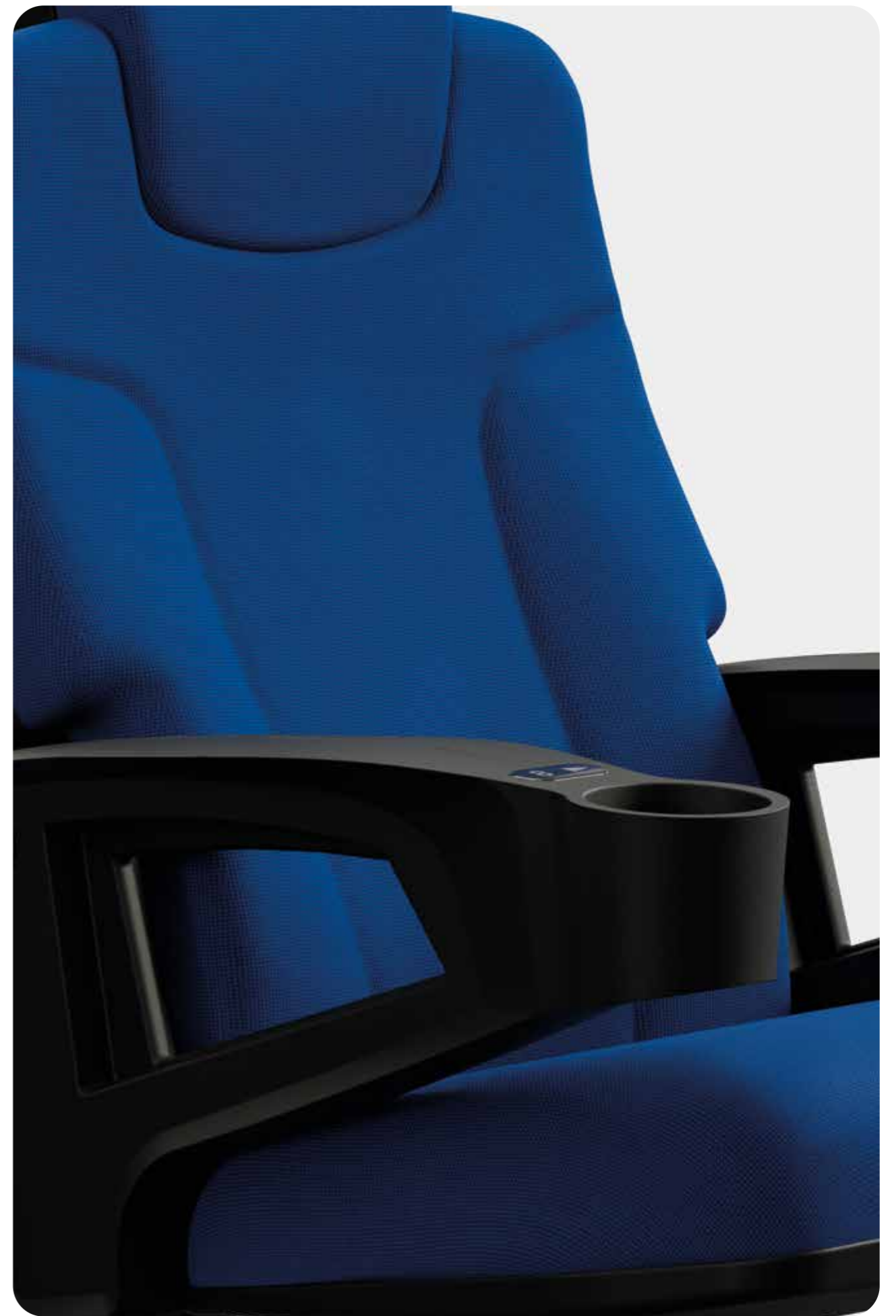

MEGA

9078

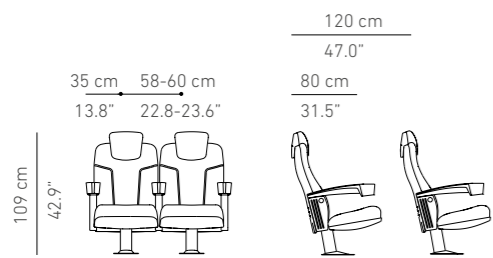
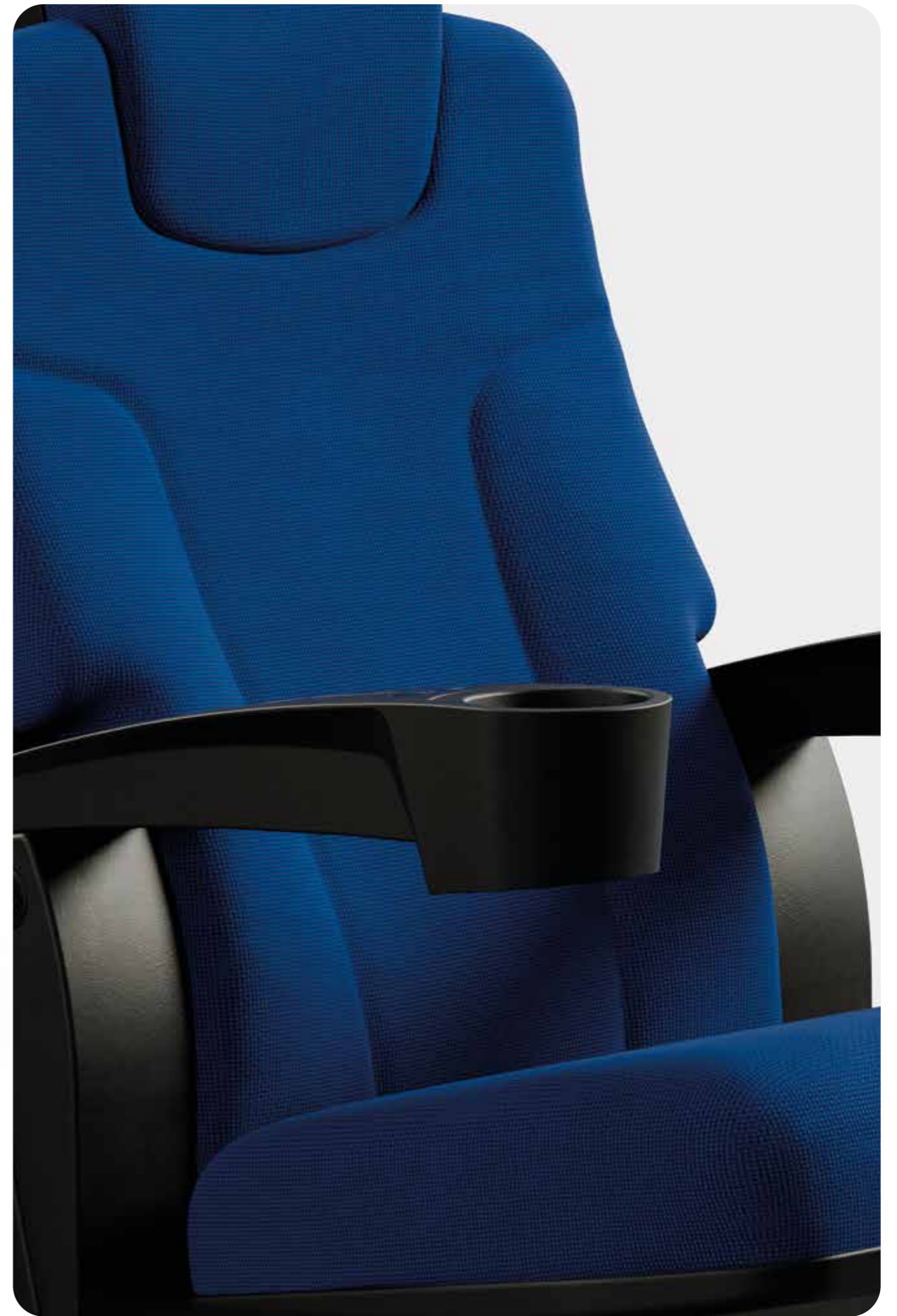

MEGA

9112, 9113, 9114, 9078



Odeon Finnkino (Helsinki, Finland)

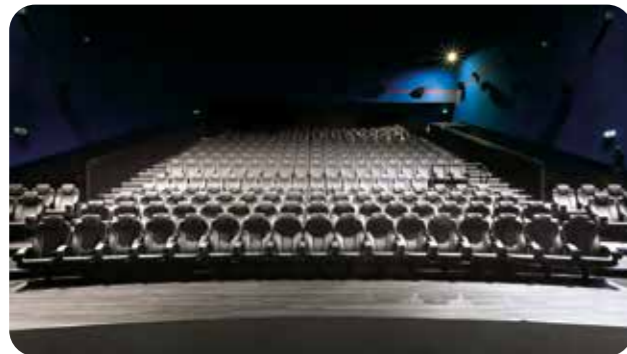

UCI Cinemas Bicocca (Milano, Italy)



Vremena Goda (Moscow, Russia)



Caribbean Cinemas - Cinestar (Guadeloupe island)



Mega 9112



Mega 9113



Mega 9078

ACCESSORIES AND FINISHES_ACCESORIOS Y ACABADOS



Mega 9114 RC
Reclining_Reclinable.



Mega 9114 RC
Seat recliner button_Botón reclinador.



Mega 9078
Cupholder with easy cleaning hole
Posavasos con agujero para fácil limpieza.



Customisable headrest: embroidery, colour, fabric.
Reposacabezas personalizable: bordado, color, tapicería.



Mega 9112
Upholstered backrest_Respaldo tapizado.

TABLES_MESAS



Plastic table medium size.
Mesa mediana de plástico.
11.81"x7.87"_300x200mm.



Plastic table small size.
Mesa pequeña de plástico.
13.18"x6.10"_335x155mm

MEGA

9042, 9043

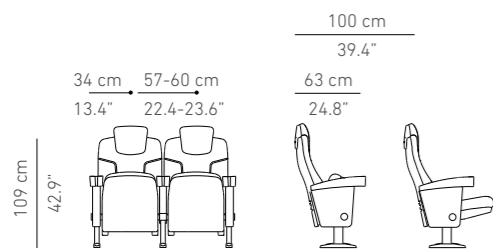

MEGA

9042, 9043



Novo Cinemas - Tawar Mall (Doha Qatar)



Novo Cinemas - Tawar Mall (Doha Qatar)



Novo Cinemas - Tawar Mall (Doha Qatar)



ACCESSORIES AND FINISHES / ACCESORIOS Y ACABADOS



Row numbering.
Númeración de fila.



Upholstered armrests.
Brazos tapizados.



Mega 9043
Central pedestal_Pie central.



Optional headrest.
Reposacabezas opcional.

MEGA

9106

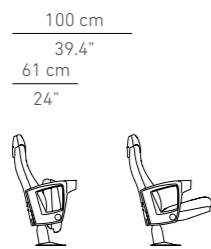
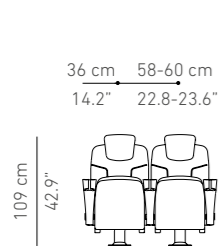

MEGA

9106



Ambassador Theatre - Taroko Park (Kaohsiung, Taiwan)



Ambassador Theatre - Taroko Park (Kaohsiung, Taiwan)



Cinemes Verdi (Barcelona, Spain)



ACCESSORIES AND FINISHES / ACCESORIOS Y ACABADOS



Row numbering.
Númeración de fila.



Optional headrest.
Reposacabezas opcional.



Central pedestal.
Pie central.

C I N E M A

SEATING COLLECTION

TOP



TOP

5042, 5043

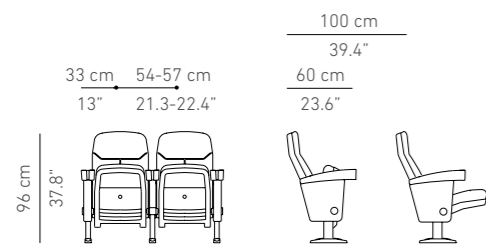
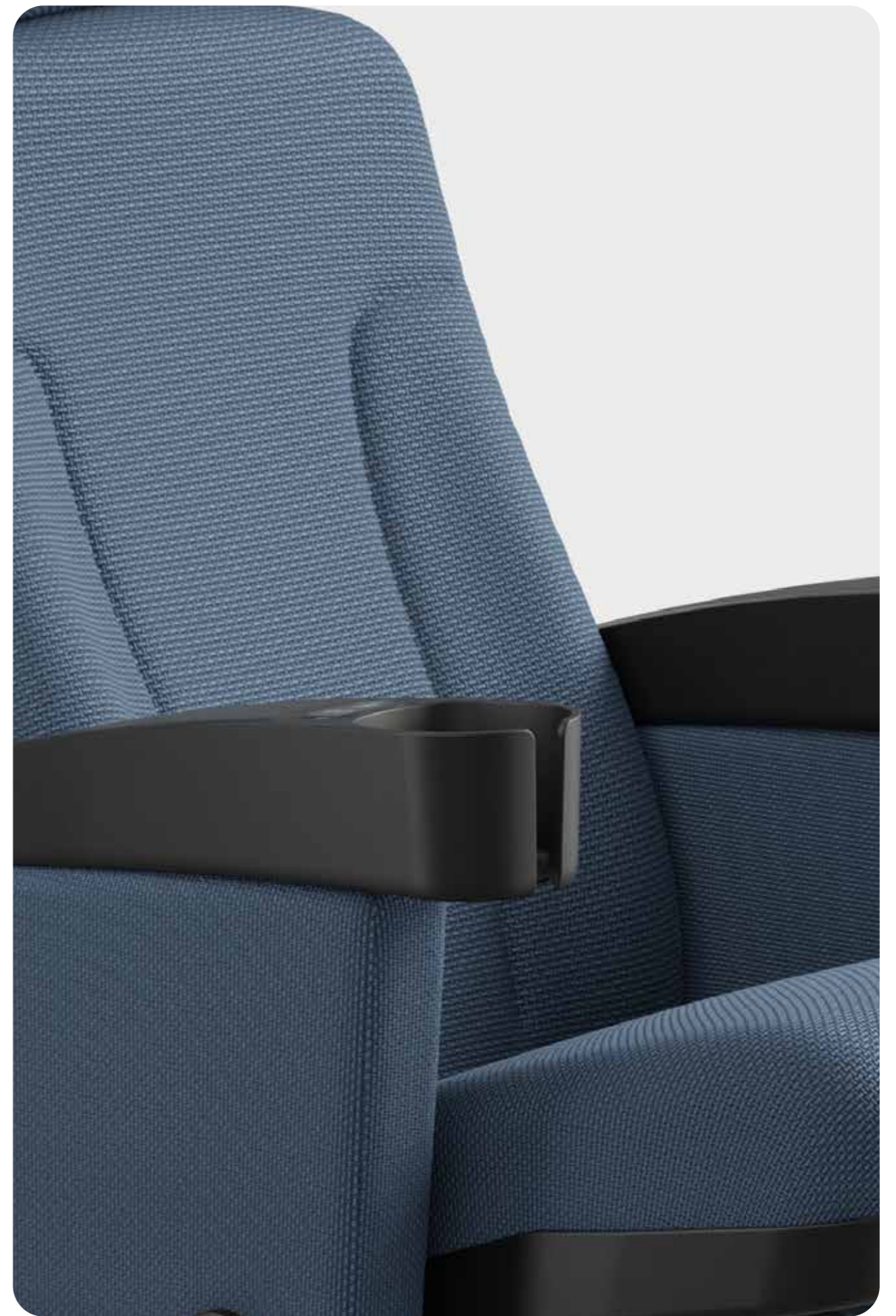

TOP

5042, 5043



BFI IMAX Waterloo (London, UK)



BFI IMAX Waterloo (London, UK)



Cinema Lumiere (Suwalki, Poland)



Top 5042



Top 5043



Top 5042 Double foot_Doble pie.

ACCESSORIES AND FINISHES_ACCESORIOS Y ACABADOS



Row numbering.
Numeración de fila.



Upholstered armrest.
Brazo tapizado.



Optional headrest.
Reposacabezas opcional.



Top 5043
Central pedestal_Pie central.

REFERENCIAS_REFERENCES



Fotokem (Budapest, Hungary)
Mega 9113



Cinema Lumiere (Suwałki, Poland)
Top 5042



Grand Cinemas ABC Verdun Mall (Beirut, Lebanon)
Smart 13011 RK



Zolotoy Duke (Odessa, Ukraine)
Hollywood Twin



Janson Tsai Design Screening Room (Shanghai, China)
Megaseat 9113



Odeon Milton Keynes (Milton Keynes, UK)
Smart 13010

REFERENCIAS_REFERENCES



BlitzMegaplex (Jakarta, Indonesia) ©Indira Sarasvati - courtesy of Blitzmegaplex
Megaseat 9113



Novo Tawar Mall (Doha, Qatar)
Hollywood Twin



Cinema City (Jerusalem, Israel)
Megaseat 9113



Medicinemas Guy's Hospital (London, UK)
Megaseat 9113

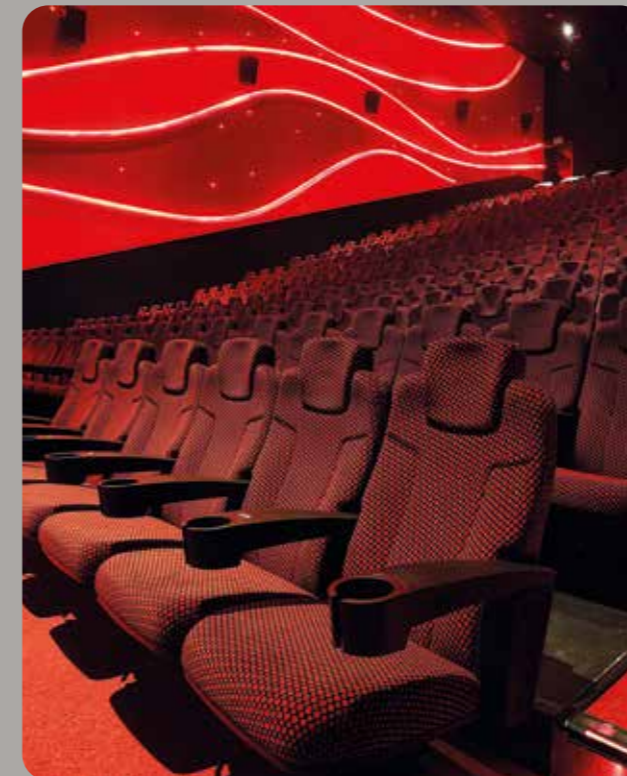

Taj Cinema (Amman, Jordania)
Megaseat 9078



Shaw Theatres - Balestier Mall (Singapore)
Riva Twin

REFERENCIAS_REFERENCES



Kosmorama (Haderslev, Denmark)
Riva RC



JT Bioscope (Eindhoven, The Netherlands)
Megaseat 9113



Haydn Kino, (Wien, Austria)
Top 5042



Kinopark (Astana, Kazajstan)
Hollywood



Cinemes Verdi (Barcelona, Spain)
Megaseat 9106



Cinema 8 (Schöffland, Switzerland)
Smart

ACCESORIES_ACCESORIES

	Lamp Luz	Lighted numbering Numeración iluminada	Cleaning system Sistema de limpieza	USB	Wireless charger Cargador inalámbrico	Privacy module Módulo de privacidad	Table Mesa
Hollywood 5400	<input type="checkbox"/>	<input type="checkbox"/>	<input type="checkbox"/>	<input type="checkbox"/>	<input type="checkbox"/>		LAT/LATD
Hollywood Twin	<input type="checkbox"/>	<input type="checkbox"/>	<input type="checkbox"/>	<input type="checkbox"/>	<input type="checkbox"/>	<input type="checkbox"/>	LAT/LATD
Riva Heritage	<input type="checkbox"/>	<input type="checkbox"/>	<input type="checkbox"/>	<input type="checkbox"/>	<input type="checkbox"/>		LAT/RT/ TFM/TFS
Riva Heritage Twin	<input type="checkbox"/>	<input type="checkbox"/>	<input type="checkbox"/>	<input type="checkbox"/>	<input type="checkbox"/>	<input type="checkbox"/>	LAT/RT/ TFM/TFS
Smart 13012 RC		<input type="checkbox"/>		<input type="checkbox"/>			ST/TFM/TFS
Smart 13011 RK		<input type="checkbox"/>		<input type="checkbox"/>			ST/TFM/TFS
Smart 13010		<input type="checkbox"/>		<input type="checkbox"/>			ST/TFM/TFS
Smart 13030		<input type="checkbox"/>		<input type="checkbox"/>			ST/TFM/TFS
Mega 9042		<input type="checkbox"/>		<input type="checkbox"/>			
Mega 9043		<input type="checkbox"/>		<input type="checkbox"/>			
Mega 9078		<input type="checkbox"/>		<input type="checkbox"/>			TFM/TFS
Mega 9106		<input type="checkbox"/>					
Mega 9112		<input type="checkbox"/>					TFM/TFS
Mega 9113		<input type="checkbox"/>		<input type="checkbox"/>			
Mega 9114 RC		<input type="checkbox"/>		<input type="checkbox"/>			TFM/TFS
Top 5042		<input type="checkbox"/>		<input type="checkbox"/>			
Top 5043		<input type="checkbox"/>		<input type="checkbox"/>			

LAT Large Aluminium Table_Mesa Grande de Aluminio
LATD Large Aluminium Table Double hinge_Mesa Grande Aluminio doble bisagra
RT Riva table_Mesa Riva
ST Smart table_Mesa Smart
TFM Plastic table, medium size_Mesa de plástico mediana
TFS Plastic table, small size_Mesa de plástico pequeña

ATTRIBUTES_ATRIBUTOS

	Headrest Reposacabeza	Cupholder Portavasos	Footrest Reposapiés	Tip Up Seat Asiento abatible	Central Pedestal Pie Central	Side Leg Pie Lateral	Upholstered armrest Brazo tapizado
Hollywood 5400	<input checked="" type="checkbox"/>	<input type="checkbox"/>	<input checked="" type="checkbox"/>				<input checked="" type="checkbox"/>
Hollywood Twin	<input checked="" type="checkbox"/>	<input type="checkbox"/>	<input checked="" type="checkbox"/>				<input checked="" type="checkbox"/>
Riva Heritage	<input checked="" type="checkbox"/>	<input checked="" type="checkbox"/>	<input checked="" type="checkbox"/>				<input checked="" type="checkbox"/>
Riva Heritage Twin	<input checked="" type="checkbox"/>	<input checked="" type="checkbox"/>	<input checked="" type="checkbox"/>				<input checked="" type="checkbox"/>
Smart 13012 RC	<input type="checkbox"/>	<input checked="" type="checkbox"/>			<input checked="" type="checkbox"/>		<input checked="" type="checkbox"/>
Smart 13011 RK	<input type="checkbox"/>	<input checked="" type="checkbox"/>			<input checked="" type="checkbox"/>		<input checked="" type="checkbox"/>
Smart 13010	<input type="checkbox"/>	<input checked="" type="checkbox"/>			<input checked="" type="checkbox"/>		<input checked="" type="checkbox"/>
Smart 13030	<input type="checkbox"/>	<input checked="" type="checkbox"/>		<input checked="" type="checkbox"/>	<input checked="" type="checkbox"/>		<input checked="" type="checkbox"/>
Mega 9042	<input type="checkbox"/>	<input checked="" type="checkbox"/>		<input checked="" type="checkbox"/>		<input checked="" type="checkbox"/>	<input type="checkbox"/>
Mega 9043	<input type="checkbox"/>	<input checked="" type="checkbox"/>		<input checked="" type="checkbox"/>	<input checked="" type="checkbox"/>		<input type="checkbox"/>
Mega 9078	<input type="checkbox"/>	<input checked="" type="checkbox"/>			<input checked="" type="checkbox"/>		
Mega 9106	<input type="checkbox"/>	<input checked="" type="checkbox"/>		<input checked="" type="checkbox"/>	<input checked="" type="checkbox"/>		
Mega 9112	<input type="checkbox"/>	<input checked="" type="checkbox"/>			<input checked="" type="checkbox"/>		
Mega 9113	<input type="checkbox"/>	<input checked="" type="checkbox"/>			<input checked="" type="checkbox"/>		<input checked="" type="checkbox"/>
Mega 9114 RC	<input type="checkbox"/>	<input checked="" type="checkbox"/>			<input checked="" type="checkbox"/>		
Top 5042	<input type="checkbox"/>	<input checked="" type="checkbox"/>		<input checked="" type="checkbox"/>		<input checked="" type="checkbox"/>	<input type="checkbox"/>
Top 5043	<input type="checkbox"/>	<input checked="" type="checkbox"/>		<input checked="" type="checkbox"/>	<input checked="" type="checkbox"/>		<input type="checkbox"/>

Included_Incluído.
 Optional_Opcional

BENEFITS_PRESTACIONES

	*	**	Fixed (no reclining) Fijo (no reclinable)	*** Recliner (SLD) with 1 motor Reclinable (SLD) con 1 motor	**** Recliner with 2 motors Reclinable con 2 motores	**** Recliner with 3 motors Reclinable con 3 motores
Hollywood			<input type="checkbox"/>	<input type="checkbox"/>	<input checked="" type="checkbox"/>	<input type="checkbox"/>
Hollywood Twin			<input type="checkbox"/>	<input type="checkbox"/>	<input checked="" type="checkbox"/>	<input type="checkbox"/>
Riva	<input type="checkbox"/>	<input type="checkbox"/>	<input type="checkbox"/>	<input type="checkbox"/>	<input checked="" type="checkbox"/>	
Riva Twin	<input type="checkbox"/>	<input type="checkbox"/>	<input type="checkbox"/>	<input type="checkbox"/>	<input checked="" type="checkbox"/>	
Smart 13010	<input type="checkbox"/>	<input type="checkbox"/>				
Smart 13011 RK	<input checked="" type="checkbox"/>					
Smart 13012 RC		<input checked="" type="checkbox"/>				
Mega 9112	<input type="checkbox"/>					
Mega 9113	<input type="checkbox"/>					
Mega 9114 RC		<input checked="" type="checkbox"/>				
Mega 9078	<input type="checkbox"/>					

- * Mechanical recliner_Reclinable mecánico
- ** Mechanical recliner with button_Reclinable mecánico con botón
- *** Only backrest or footrest_Solo respaldo o reposapiés
- **** Backrest and footrest_Respaldo y reposapiés
- ***** Backrest, footrest and headrest_Respaldo, reposapiés y reposacabezas

- Included_Incluido.
- Optional_Opcional
- SLD** Slider_Slider.

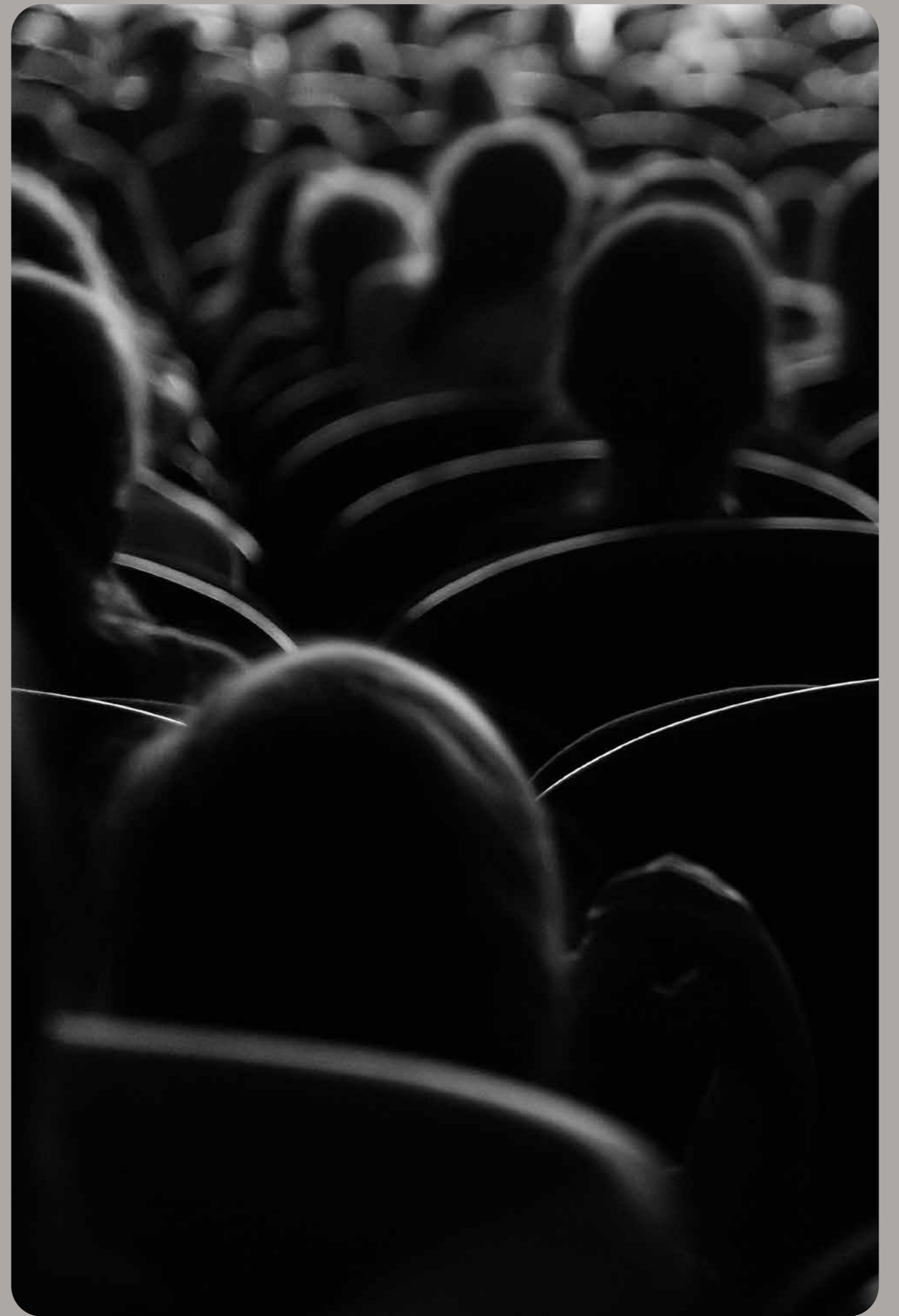

●●  FIGUERAS

